

TMBR20100CT

Dual Common-Cathode Ultra Low VF Schottky Rectifier

Features

- Guard ring for overvoltage protection
- Lower power losses, high efficiency
- Low forward voltage drop
- Low leakage current
- High forward surge capability
- High frequency operation
- Solder Dip 260 °C, 40 s
- RoHS compliant package

Applications

For use in high frequency rectifier of switching mode power supplies, free wheeling diodes, dc-to-dc converters or polarity protection application.

Mechanical Data

- Case: TO-220AB
- Molding compound meets UL 94 V-0 flammability
- Terminals: Matte tin plated leads
- Polarity: As marked
- Weight: 2.24 grams
- Mounting Torque: 10 in-lbs maximum

Packing & Order Information

50/Tube ; 1,000/Box



**RoHS
COMPLIANT**

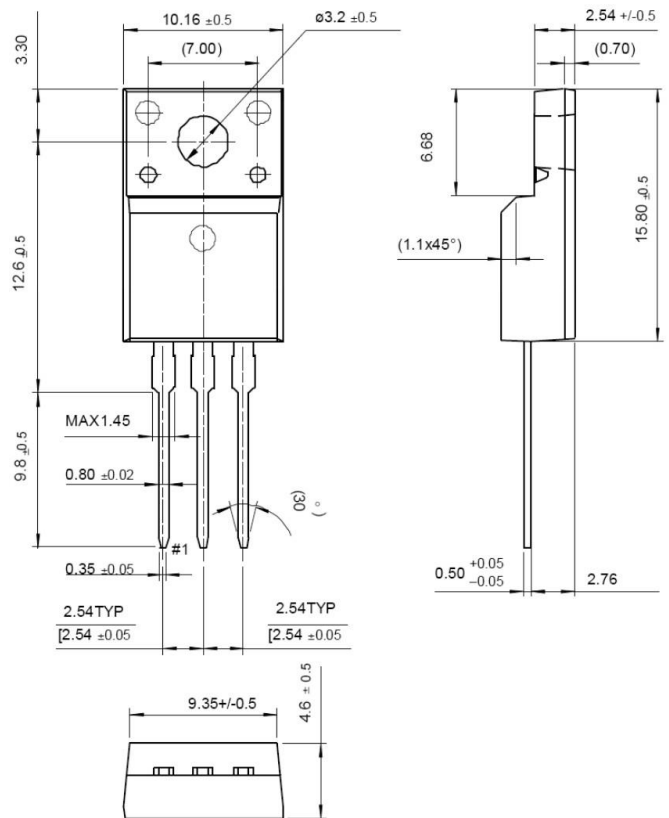

Graphic symbol

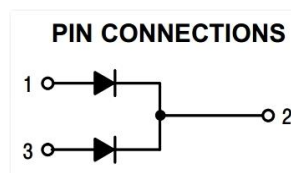

TMBR20100CT

Dual Common-Cathode
Ultra Low VF Schottky Rectifier

MAXIMUM RATINGS AND ELECTRICAL CHARACTERISTICS

Maximum Ratings (Tc=25°C unless otherwise noted)

Parameter	Symbol	TMBR20100CT	Unit
Maximum repetitive peak reverse voltage	VRRM	100	V
Working peak reverse voltage	VRWM	100	V
Maximum DC blocking voltage	VDC	100	V
Maximum average forward rectified current Total device	IF(AV)	10	A
Average Rectified Forward Current	Io(AV)	20	A
Peak forward surge current 8.3ms single half sine-wave superimposed on rated load (JEDEC Method)	IFSM	120	A
Operating junction temperature range	TJ	-55 to +150	°C
Storage temperature range	TSTG	-55 to +150	°C

Electrical characteristics (Tc=25°C unless otherwise noted)

Parameter	Symbol	Value		Unit
		Typical	Max	
Instantaneous forward voltage at IF=10A, Tj=25°C at IF=10A, Tj=125°C	VF	0.70 0.62	0.75 0.70	V
Maximum reverse current per leg at working peak reverse voltage	IR	200		u'A
Tj=25°C Tj=125°C		1		m'A

Notes :

- (1) Pulse test: 300 µs pulse width, 1 % duty cycle
- (2) Pulse test: Pulse width ≤ 40 ms

Thermal characteristics (Tc=25°C unless otherwise noted)

Parameter	Symbol	Value	Unit
Typical thermal resistance	Rthjc	4	°C/W
	RθJA	60	

TMBR20100CT

Dual Common-Cathode
Ultra Low VF Schottky Rectifier

■ TYPICAL CHARACTERISTICS @ $T_a=25^\circ\text{C}$ unless otherwise specified

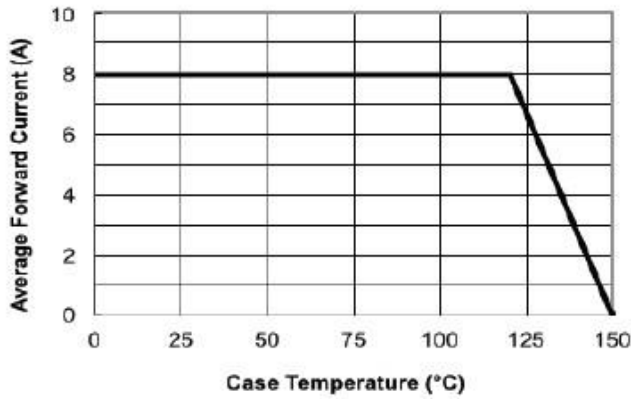

Figure 1. Forward Current Derating Curve

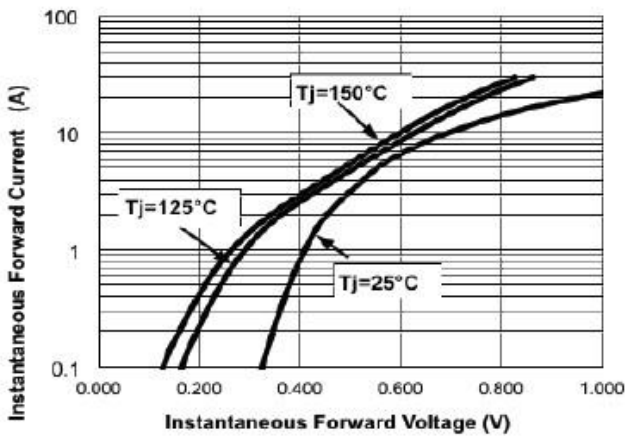
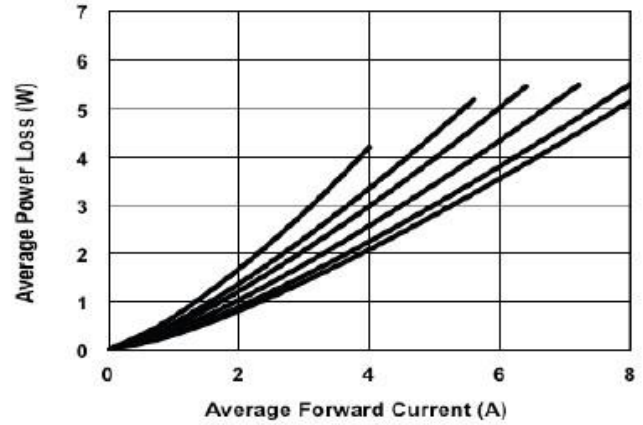

Figure 3. Typical Instantaneous Forward Characteristics Per Leg

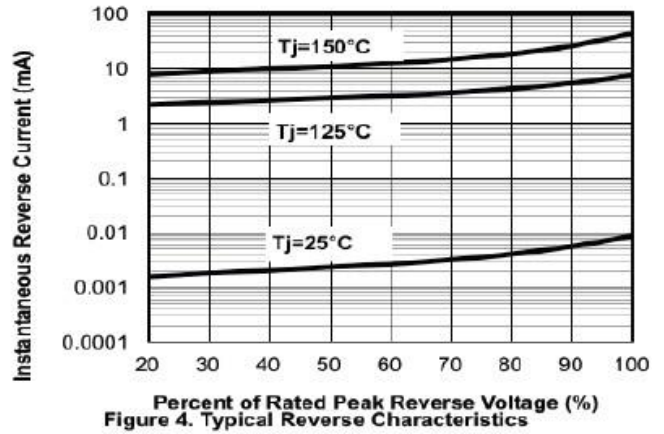

Figure 4. Typical Reverse Characteristics

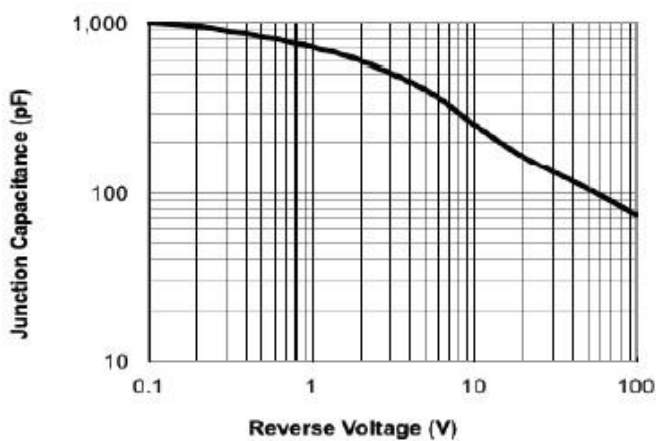

Figure 5. Typical Junction Capacitance

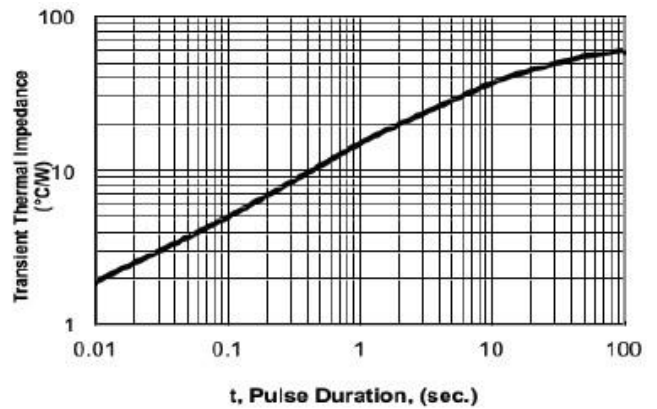

Figure 6. Typical Transient Thermal Impedance

TMBR20100CT

Dual Common-Cathode

Ultra Low VF Schottky Rectifier

Disclaimer

ALL PRODUCT, PRODUCT SPECIFICATIONS AND DATA ARE SUBJECT TO CHANGE

WITHOUT NOTICE TO IMPROVE RELIABILITY, FUNCTION OR DESIGN OR OTHERWISE.

Bruckewell Technology Inc., its affiliates, agents, and employees, and all persons acting on its or their behalf (collectively, "Bruckewell"), disclaim any and all liability for any errors, inaccuracies or incompleteness contained in any datasheet or in any other disclosure relating to any product.

Bruckewell makes no warranty, representation or guarantee regarding the suitability of the products for any particular purpose or the continuing production of any product. To the maximum extent permitted by applicable law, Bruckewell disclaims

- (i) Any and all liability arising out of the application or use of any product.
- (ii) Any and all liability, including without limitation special, consequential or incidental damages.
- (iii) Any and all implied warranties, including warranties of fitness for particular purpose, non-infringement and merchantability.

Statements regarding the suitability of products for certain types of applications are based on Bruckewell's knowledge of typical requirements that are often placed on Bruckewell products in generic applications.

Such statements are not binding statements about the suitability of products for a particular application. It is the customer's responsibility to validate that a particular product with the properties described in the product specification is suitable for use in a particular application. Parameters provided in datasheets and/or specifications may vary in different applications and performance may vary over time.

Product specifications do not expand or otherwise modify Bruckewell's terms and conditions of purchase, including but not limited to the warranty expressed therein.