

MSU5N50

500V N-Channel MOSFET

Description

The MSU5N50 is a N-channel enhancement-mode MOSFET, providing the designer with the best combination of fast switching, ruggedized device design, low on-resistance and cost effectiveness. The TO-251 package is universally preferred for all commercial-industrial applications

Features

- Originative New Design
- Rugged Gate Oxide Technology
- Extremely Low Intrinsic Capacitances
- Remarkable Switching Characteristics
- Unequalled Gate Charge : 2.5 nC (Typ.)
- Extended Safe Operating Area
- Lower RDS(ON) : 1.1 Ω (Typ.) @VGS=10V
- 100% Avalanche Tested
- RoHS compliant package

Packing & Order Information

80/Tube ; 4,000/Box

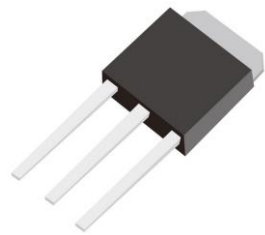

**RoHS
COMPLIANT**

Graphic symbol

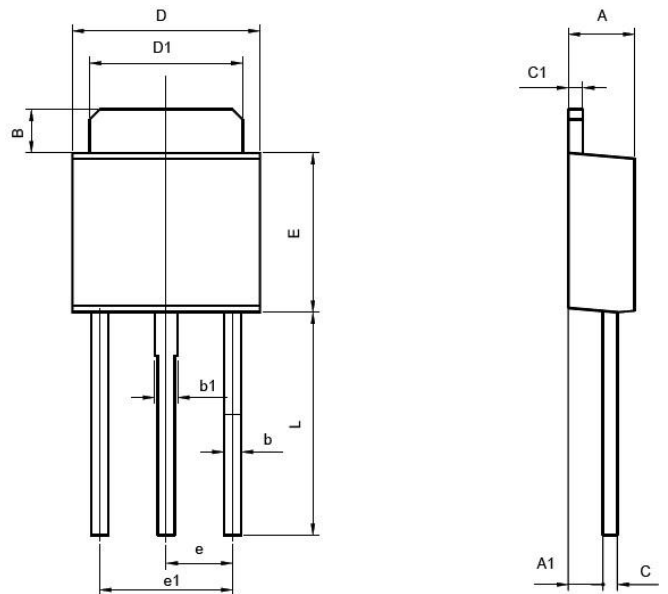
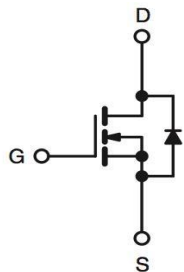

Symbol	Dimensions in Millimeters		Dimensions in Inches	
	min	max	min	max
A	2.15	2.45	0.85	0.96
A1	1.00	1.40	0.39	0.55
B	1.25	1.75	0.49	0.69
b	0.45	0.75	0.18	0.3
b1	0.65	0.95	0.26	0.37
C	0.38	0.64	0.15	0.25
C1	0.38	0.64	0.15	0.25
D	6.30	6.70	2.48	2.64
D1	5.10	5.50	2.01	2.17
E	5.30	5.70	2.09	2.24
e	2.3 (typ.)		0.91 (typ.)	
e1	4.4	4.8	1.73	1.89
L	7.4	8.0	2.91	3.15

MSU5N50

500V N-Channel MOSFET

MAXIMUM RATINGS AND ELECTRICAL CHARACTERISTICS

Absolute Maximum Ratings (Tc=25°C unless otherwise noted)

Symbol	Parameter	Value	Unit
V _{DSS}	Drain-Source Voltage	500	V
V _{GS}	Gate-Source Voltage	±30	V
I _D	Drain Current -Continuous (TC=25°C)	5	A
	Drain Current -Continuous (TC=100°C)	3	A
I _{DM}	Drain Current Pulsed	20	A
E _{AS}	Single Pulsed Avalanche Energy	305	mJ
E _{AR}	Repetitive Avalanche Energy	7.6	mJ
dV/dt	Peak Diode Recovery dV/dt	4.5	V/ns
P _D	Power Dissipation (TC = 25 °C)	40	W
	- Derate above 25°C	0.32	W/°C
T _J ,T _{STG}	Operating and Storage Temperature Range	-55 to +150	°C
T _L	Maximum lead temperature for soldering purposes, 1/8" from case for 5 seconds	300	°C

- Drain current limited by maximum junction temperature

Thermal Resistance Characteristics

Symbol	Parameter	Max.	Units
R _{θJC}	Junction-to-Case	2.3	°C/W
R _{θJA}	Junction-to-Ambient	110	

On Characteristics

Symbol	Test Conditions	Min	Typ.	Max.	Units
V _{GS}	V _{DS} = V _{GS} , I _D = 250μA	2.0	--	4.0	V
*R _{DS(ON)}	V _{GS} = 10 V , I _D = 2.25 A	--	2.0	1.5	Ω

Off Characteristics

Symbol	Test Conditions	Min	Typ.	Max.	Units
BV _{DSS}	V _{GS} = 0 V , I _D = 250μA	500	--	--	V
ΔBV _{DSS} / ΔT _J	I _D = 250μA, Referenced to 25°C	--	0.6	--	V/°C
I _{DSS}	V _{DS} = 500 V , V _{GS} = 0 V	--	--	1	μA
	V _{DS} = 400 V , V _C = 125°C	--	--	10	
I _{GSSF}	V _{GS} = 30 V , V _{DS} = 0 V	--	--	100	nA
I _{GSSR}	V _{GS} = -30 V , V _{DS} = 0 V	--	--	-100	nA

MSU5N50

500V N-Channel MOSFET

Switching Characteristics

Symbol	Test Conditions	Min	Typ.	Max.	Units
$t_{d(on)}$	$V_{DS} = 250 \text{ V}, I_D = 5 \text{ A},$ $R_G = 25 \Omega$	--	10	--	ns
t_r		--	50	--	ns
$t_{d(off)}$		--	50	--	ns
t_f		--	50	--	ns
Q_g	$V_{DS} = 400 \text{ V}, I_D = 5 \text{ A},$ $V_{GS} = 10 \text{ V}$	--	20	--	nC
Q_{gs}		--	2.5	--	nC
Q_{gd}		--	10	--	nC
C_{ISS}	$V_{DS} = 25 \text{ V}, V_{GS} = 0 \text{ V},$ $F = 1.0 \text{ MHz}$	--	520	670	pF
C_{OSS}		--	80	104	pF
C_{RSS}		--	15	20	pF

Source-Drain Diode Maximum Ratings and Characteristics

Symbol	Parameter	Test Conditions	Min	Typ.	Max.	Units
I_S			--	--	5	A
I_{SM}			--	--	20	
V_{SD}	$I_S = 5 \text{ A}, V_{GS} = 0 \text{ V}$		--	--	1.4	V
t_{rr}	$I_S = 5 \text{ A}, V_{GS} = 0 \text{ V}$		--	260	--	ns
Q_{rr}			$diF/dt = 100 \text{ A}/\mu\text{s}$	--	2.1	--

Notes ;

1. Repetitive Rating: Pulse width limited by maximum junction temperature
2. $L = 22 \text{ mH}, I_{AS} = 5 \text{ A}, V_{DD} = 50 \text{ V}, R_G = 25 \Omega$, Starting $T_J = 25^\circ\text{C}$
3. $I_{SD} \leq 5 \text{ A}, di/dt \leq 100 \text{ A}/\mu\text{s}, V_{DD} \leq BV_{DSS}$, Starting $T_J = 25^\circ\text{C}$
4. Pulse Test: Pulse Width $\leq 300 \mu\text{s}$, Duty Cycle $\leq 2\%$
5. Essentially Independent of Operating Temperature

MSU5N50

500V N-Channel MOSFET

Characteristics Curve

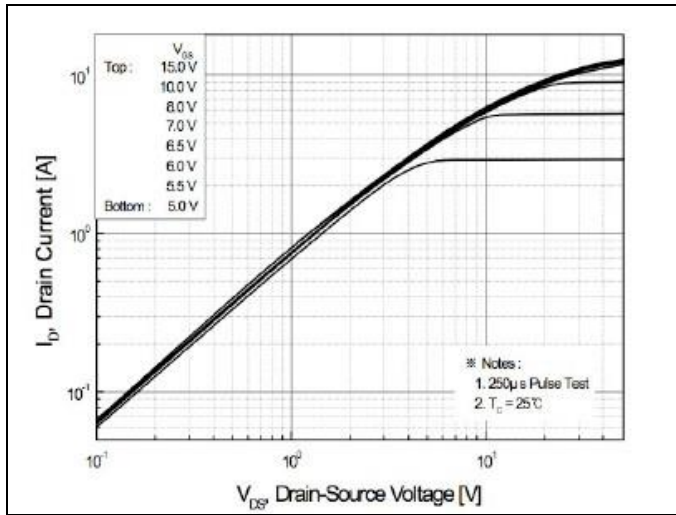

FIG.1-ON REGION CHARACTERISTICS

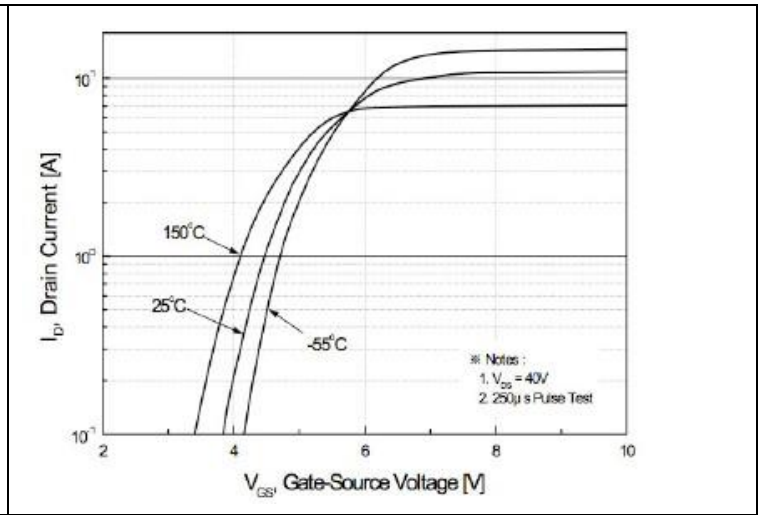

FIG.2-TRANSFER CHARACTERISTICS

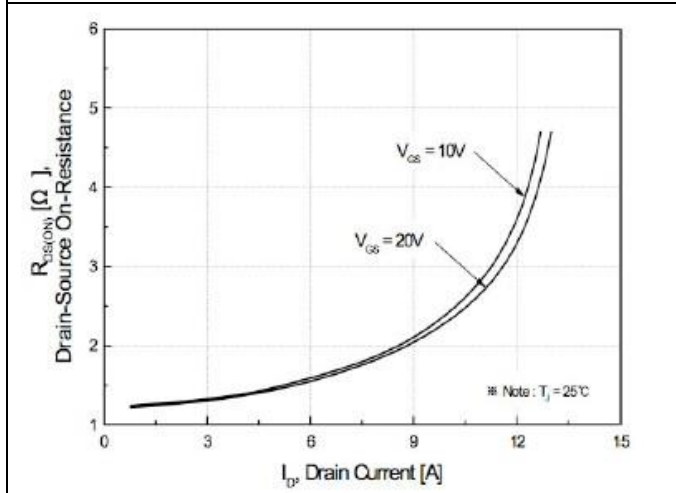

FIG.3-ON RESISTANCE VARIATION VS DRAIN CURRENT AND GATE VOLTAGE

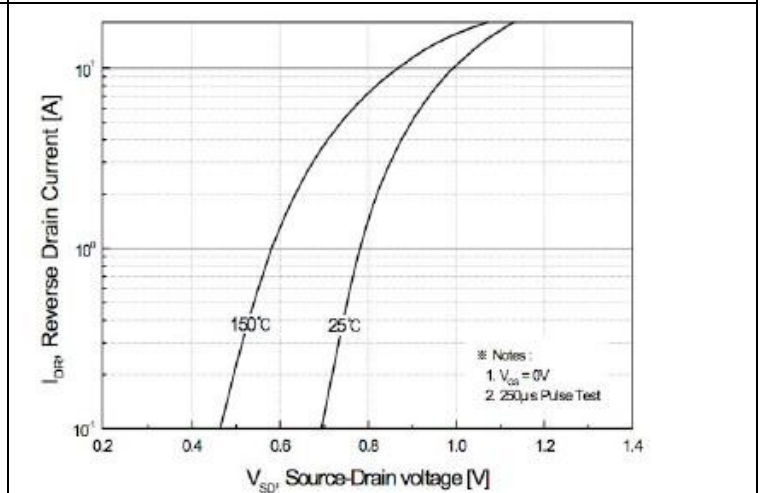

FIG.4-BODY DIODE FORWARD VOLTAGE VARIATION WITH SOURCE CURRENT AND TEMPERATURE

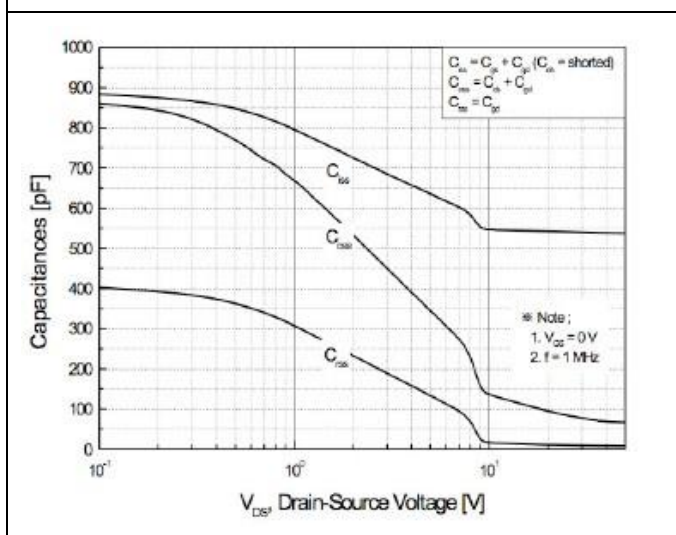

FIG.5-CAPACITANCE CHARACTERISTICS

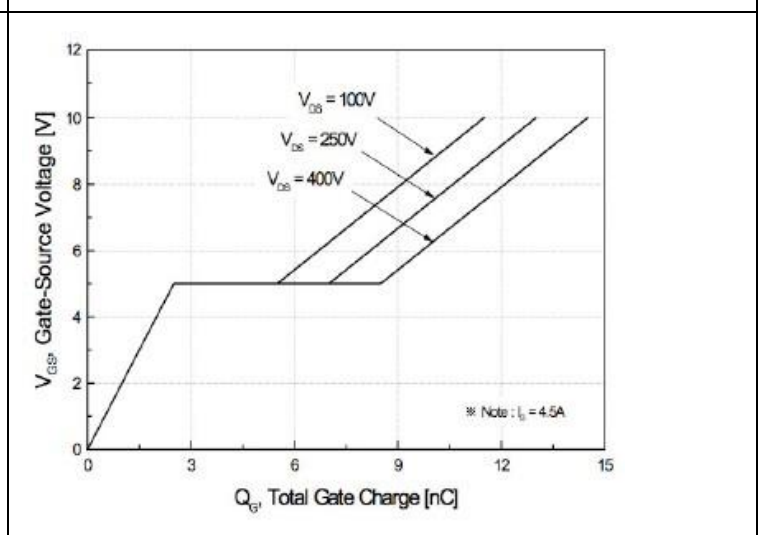

FIG.6-GATE CHARGE CHARACTERISTICS

MSU5N50

500V N-Channel MOSFET

Characteristics Curve

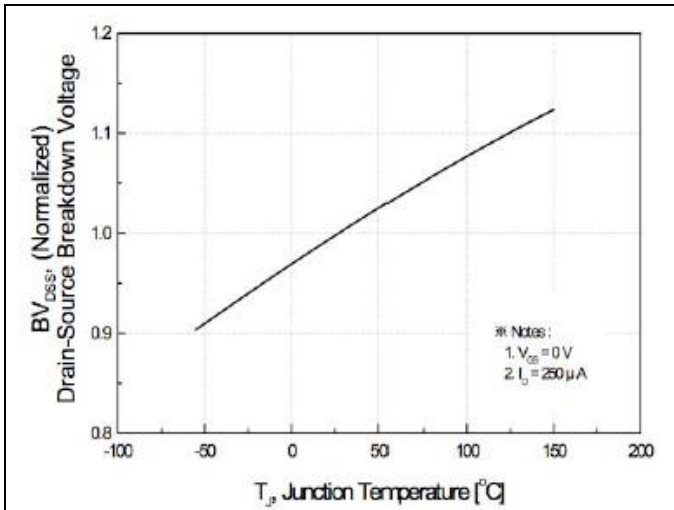

FIG.7-BREAKDOWN VOLTAGE VARIATION VS TEMPERATURE

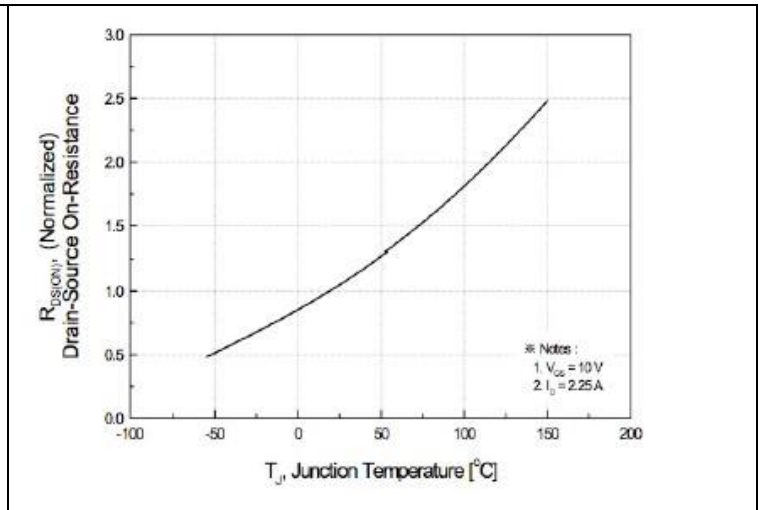

FIG.8-ON-RESISTANCE VARIATION VS TEMPERATURE

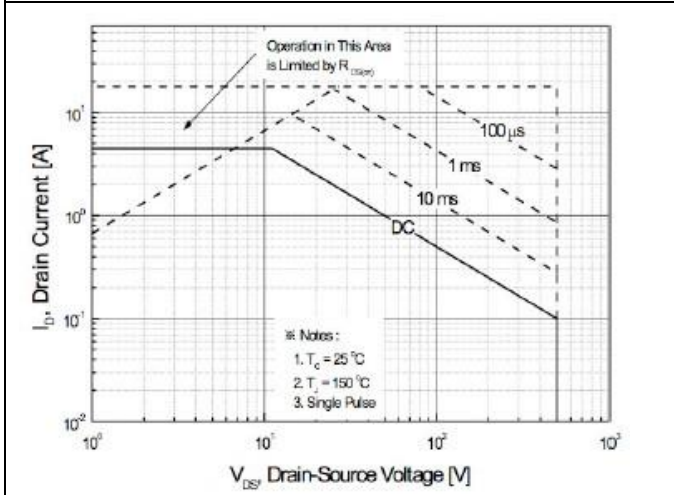

FIG.9-MAXIMUM SAFE OPERATING AREA

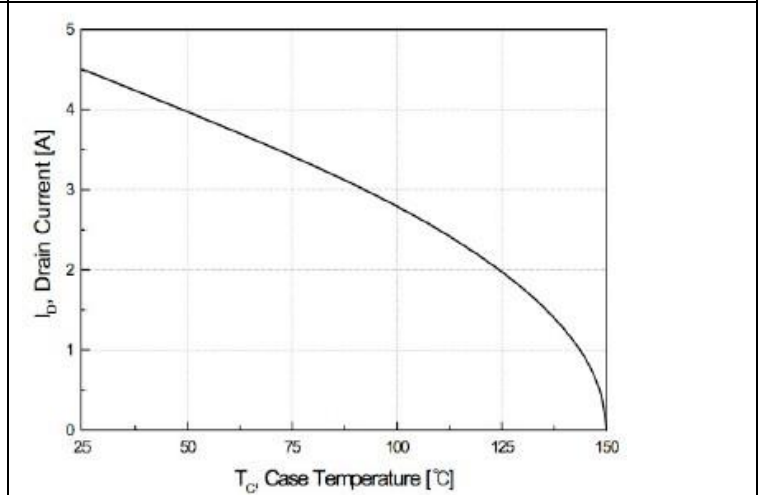

FIG.10-MAXIMUM DRAIN CURRENT VS CASE TEMPERATURE

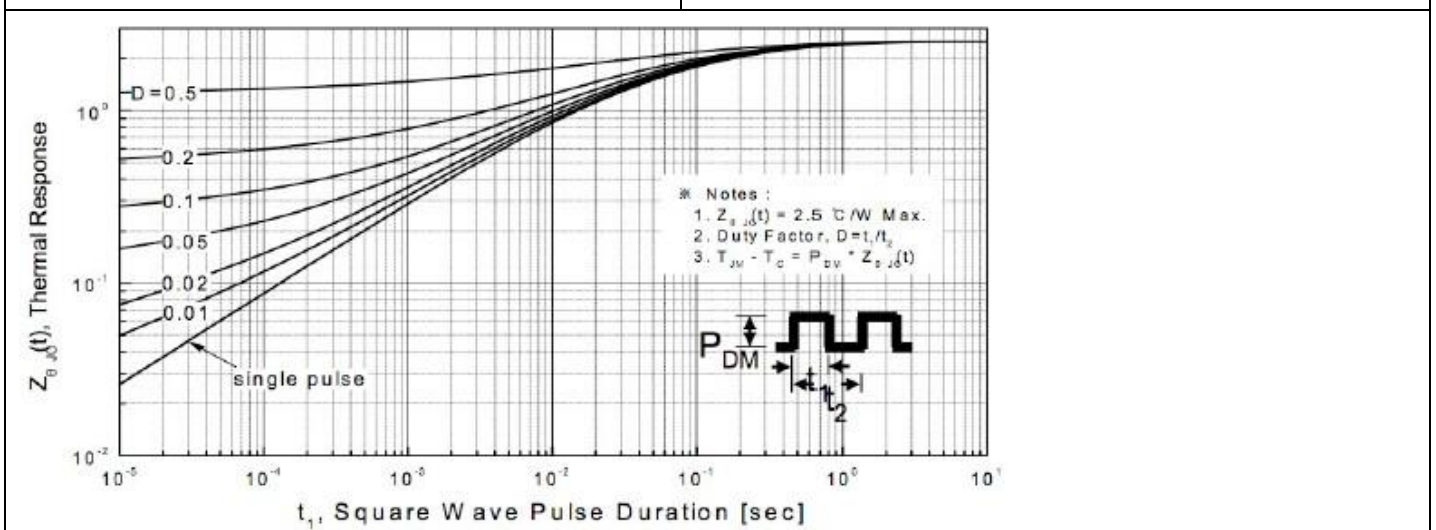

FIG.11-TRANSIENT THERMAL RESPONSE CURVE

MSU5N50

500V N-Channel MOSFET

Disclaimer

ALL PRODUCT, PRODUCT SPECIFICATIONS AND DATA ARE SUBJECT TO CHANGE

WITHOUT NOTICE TO IMPROVE RELIABILITY, FUNCTION OR DESIGN OR OTHERWISE.

Bruckewell Technology Inc., its affiliates, agents, and employees, and all persons acting on its or their behalf (collectively, "Bruckewell"), disclaim any and all liability for any errors, inaccuracies or incompleteness contained in any datasheet or in any other disclosure relating to any product.

Bruckewell makes no warranty, representation or guarantee regarding the suitability of the products for any particular purpose or the continuing production of any product. To the maximum extent permitted by applicable law, Bruckewell disclaims

- (i) Any and all liability arising out of the application or use of any product.
- (ii) Any and all liability, including without limitation special, consequential or incidental damages.
- (iii) Any and all implied warranties, including warranties of fitness for particular purpose, non-infringement and merchantability.

Statements regarding the suitability of products for certain types of applications are based on Bruckewell's knowledge of typical requirements that are often placed on Bruckewell products in generic applications.

Such statements are not binding statements about the suitability of products for a particular application. It is the customer's responsibility to validate that a particular product with the properties described in the product specification is suitable for use in a particular application. Parameters provided in datasheets and/or specifications may vary in different applications and performance may vary over time.

Product specifications do not expand or otherwise modify Bruckewell's terms and conditions of purchase, including but not limited to the warranty expressed therein.