

MSP650N700

N-Channel 650-V (D-S) MOSFET

Description

The device is using advanced Super-Junction technology. This advanced technology has been especially tailored to minimize conduction loss, provide superior switching performance and withstand high energy pulse in the avalanche and commutation mode. These devices are well suited for AC/DC power conversion in switching mode operation for higher efficiency.

Features

- 7A, 650V, $R_{DS(ON)typ} = 0.55\Omega @ V_{GS} = 10V$
- Low Gate Charge (typical 16nC)
- High Ruggedness
- Fast Switching
- 100% Avalanche Tested
- Improved dv/dt Capability
-

Typical Applications

- Switching Mode Power Supply
- Adapter / Charger
- Server Power

Package type : TO-220



Graphic Symbol

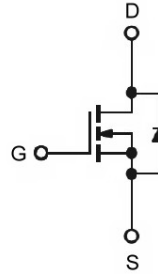

Package Dimension

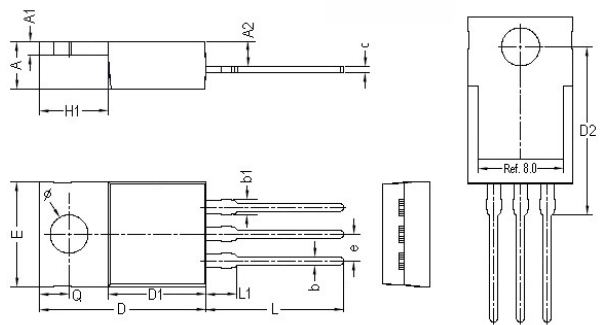

REF.	Millimeter		REF.	Millimeter	
	Min.	Max.		Min.	Max.
A	4.30	4.70	D2	15.70	17.00
A1	1.20	1.40	E	9.70	10.36
A2	2.30	2.79	e	2.54 BSC	
b	0.70	0.90	H1	6.10	6.70
b1	1.20	1.75	L	12.80	13.90
c	0.34	0.60	L1	-	4.00
D	14.70	16.10	Q	2.60	3.00
D1	8.60	9.30	Ø	3.55	3.95

RoHS Compliant

MSP650N700

N-Channel 650-V (D-S) MOSFET

MAXIMUM RATINGS AND ELECTRICAL CHARACTERISTICS

Absolute Maximum Ratings

Symbol	Parameter	Value	Units
V_{DS}	Drain-Source Voltage	650	V
V_{GS}	Gate-Source Voltage	± 30	V
I_D	Continuous Drain Current ¹ ($T_C = 25^\circ\text{C}$)	7.0	A
	Continuous Drain Current ¹ ($T_C = 100^\circ\text{C}$)	4.4	A
I_{DM}	Pulsed Drain Current ^{1,2}	28	A
I_{AS}	Single Pulse Avalanche Current, $L = 79\text{mH}^3$	2.4	A
E_{AS}	Single Pulse Avalanche Energy, $L = 79\text{mH}^3$	227	mJ
dv/dt	Peak Diode Recovery dv/dt	15	V/ns
P_D	Power Dissipation ⁴ ($T_C = 25^\circ\text{C}$)	62.5	W
	Derating Factor Above 25°C	0.5	W/ $^\circ\text{C}$
T_J/T_{STG}	Operating Junction and Storage Temperature	-55 to +150	$^\circ\text{C}$

Thermal Resistance Ratings

Symbol	Parameter	Maximum	Units
$R_{\theta JA}$	Maximum Junction-to-Ambient ¹	62.5	$^\circ\text{C}/\text{W}$
$R_{\theta JC}$	Maximum Junction-to-Case ¹	2	$^\circ\text{C}/\text{W}$

Electrical Characteristics ($T_J = 25^\circ\text{C}$ unless otherwise specified)

Symbol	Parameter	Test Conditions	Min.	Typ.	Max.	Units
$V_{GS(th)}$	Gate Threshold Voltage	$V_{DS} = V_{GS}$, $I_D = 250\mu\text{A}$	2.0	-	4.0	V
BV_{DSS}	Drain-Source Breakdown Voltage	$V_{GS} = 0\text{V}$, $I_D = 250\mu\text{A}$	650	-	-	V
$BV_{DSS} / \Delta T_J$	Breakdown Voltage Temperature Coefficient	$I_D = 250\mu\text{A}$, referenced to 25°C	-	0.68	-	V/ $^\circ\text{C}$
I_{GSS}	Gate-Source Leakage Current	$V_{DS} = 0\text{V}$, $V_{GS} = \pm 30\text{V}$	-	-	± 100	nA
I_{DSS}	Drain-Source Leakage Current	$V_{DS} = 650\text{V}$, $V_{GS} = 0\text{V}$, $T_C = 25^\circ\text{C}$	-	-	1	μA
		$V_{DS} = 520\text{V}$, $V_{GS} = 0\text{V}$, $T_C = 125^\circ\text{C}$	-	-	10	μA
$R_{DS(on)}$	Static Drain-Source On-Resistance	$V_{GS} = 10\text{V}$, $I_D = 3.5\text{A}$	-	0.55	0.7	Ω
R_g	Gate Resistance	$V_{GS} = V_{DS} = 0\text{V}$, $f = 1.0\text{MHz}$	-	2.4	-	Ω

MSP650N700

N-Channel 650-V (D-S) MOSFET

Dynamic						
Symbol	Parameter	Test Conditions	Min.	Typ.	Max.	Units
Q _g	Total Gate Charge ²	V _{DS} = 520V	--	16	--	nC
Q _{gs}	Gate-Source Charge	I _D = 7A	--	3.6	--	
Q _{gd}	Gate-Drain Charge	V _{GS} = 10V	--	8.3	--	
t _{d(on)}	Turn-On Delay Time ²	V _{DS} = 325V	--	10	--	ns
t _r	Rise Time	I _D = 7A	--	29	--	
t _{d(off)}	Turn-Off Delay Time	V _{GS} = 10V	--	44	--	
t _f	Fall Time	R _G = 24Ω	--	26	--	
C _{ISS}	Input Capacitance	V _{DS} = 100V	--	423	--	pF
C _{OSS}	Output Capacitance	V _{GS} = 0V	--	27	--	
C _{RSS}	Reverse Transfer Capacitance	f = 1.0MHz	--	1.9	--	

Source-Drain Diode						
Symbol	Parameter	Test Conditions	Min.	Typ.	Max.	Units
I _S	Continuous Source Current ^{1,5}	V _G = V _D = 0V, Force Current	-	-	7.0	A
I _{SM}	Pulsed Source Current ^{2,5}		-	-	28	
V _{SD}	Diode Forward Voltage ²	I _S = 7A, V _{GS} = 0V, T _J = 25°C	-	-	1.4	V
t _{rr}	Reverse Recovery Time ²	I _S = 7A, V _{GS} = 0V, dI _F / dt = 100A/μs		346		ns
Q _{rr}	Reverse Recovery Charge ²				2.5	

Notes

1. The data tested by surface mounted on a 1 inch² FR-4 board with 20Z copper.
2. The data tested by pulsed, pulse width ≤ 300us, duty cycle ≤ 2%.
3. The EAS data shows maximum rating. The test condition is V_{DD} = 100V, L = 79mH, I_{AS} = 2.4A.
4. The power dissipation is limited by 150°C junction temperature.
5. The data is theoretically the same as I_D and I_{DM}, in real applications, should be limited by total power dissipation.

MSP650N700

N-Channel 650-V (D-S) MOSFET

- Typical Electrical Characteristics

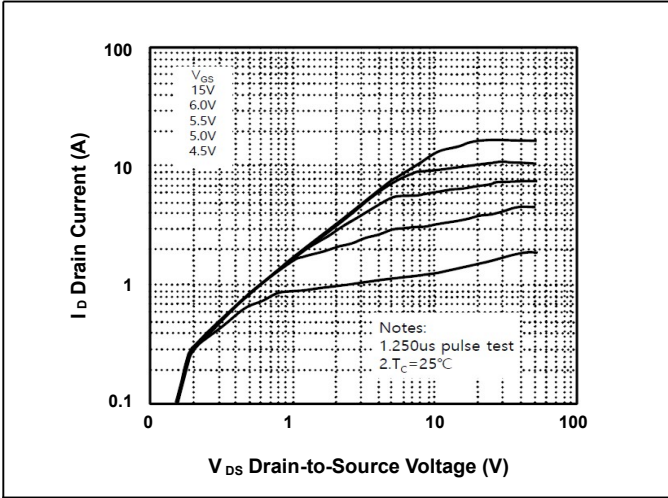

FIG.1-Typical Output Characteristics

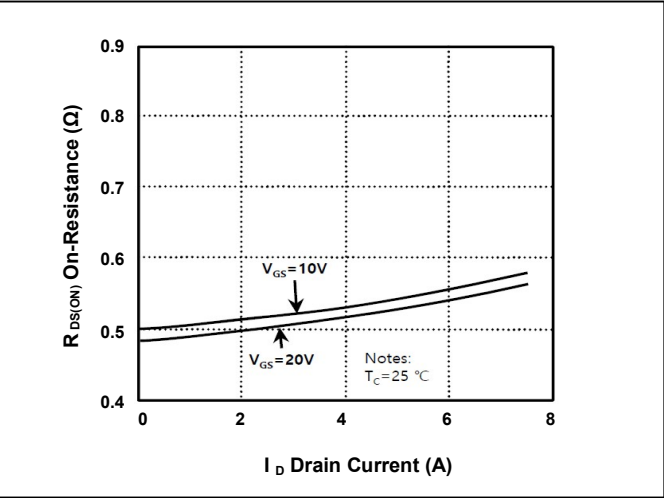

FIG.2-On-Resistance vs. Drain Current and V_{GS}

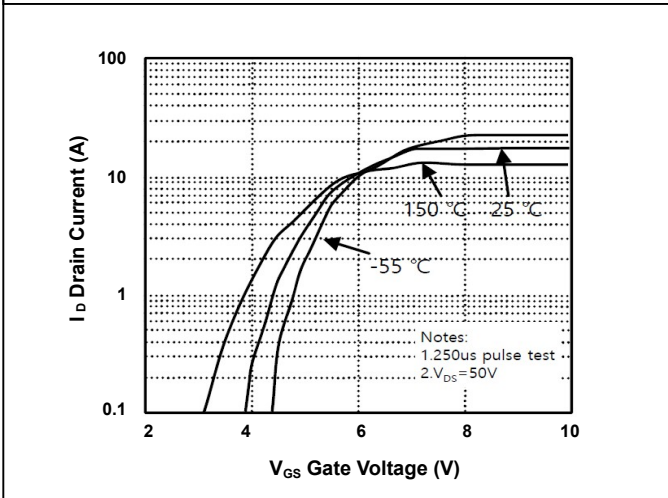

FIG.3-Transfer Characteristics

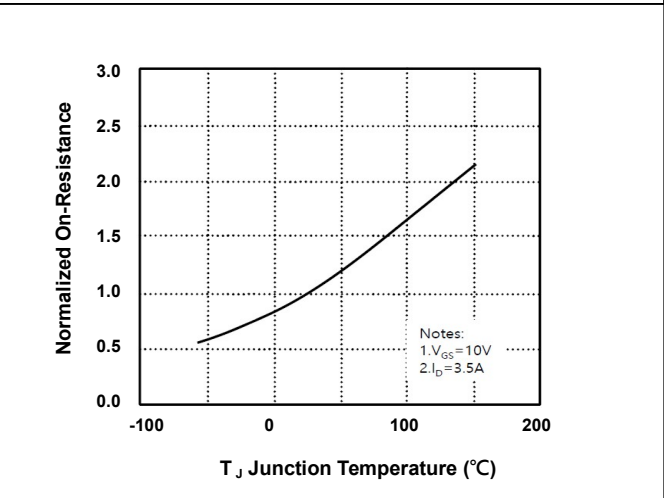

FIG.4-Normalized $R_{DS(ON)}$ vs. T_J

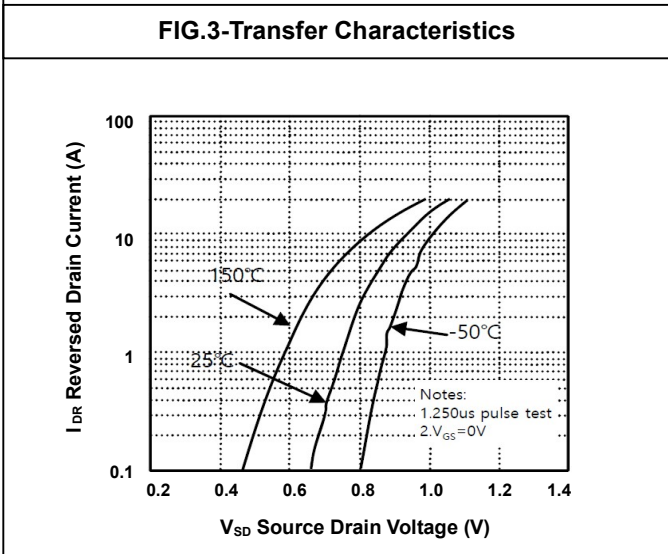

FIG.5-Body Diode Forward Voltage Variation

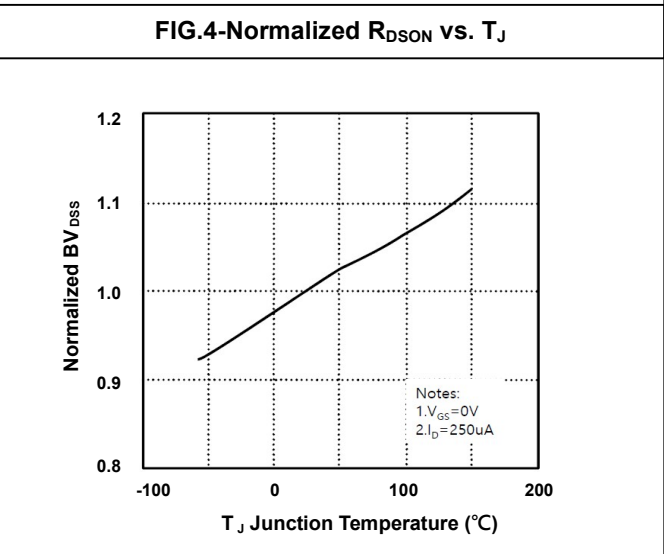

FIG.6-Breakdown Voltage Variation vs Temperature

MSP650N700

N-Channel 650-V (D-S) MOSFET

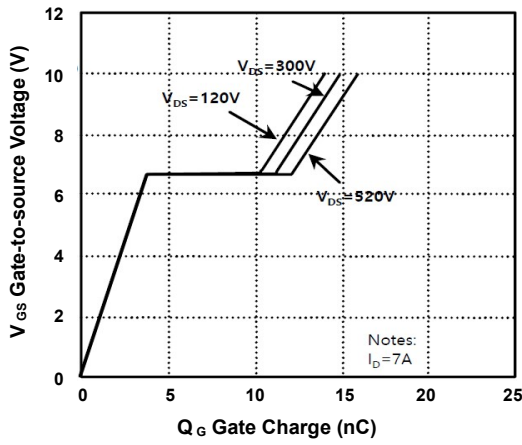

FIG.7-Gate Charge Characteristics

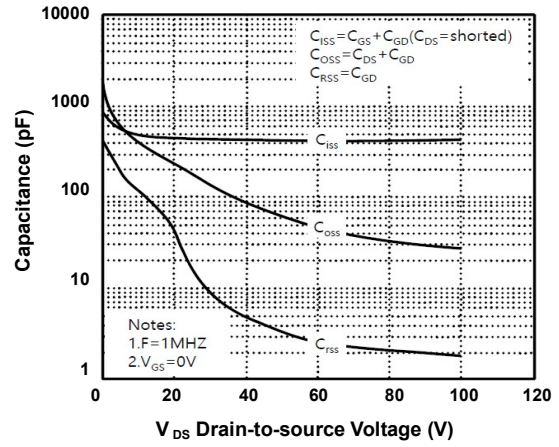

FIG.8-Capacitance Characteristics

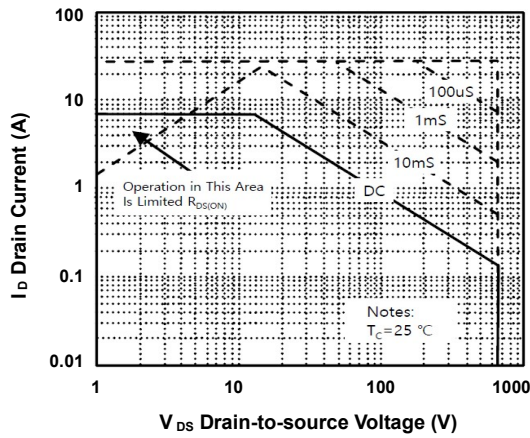

FIG.9-Safe Operating Area

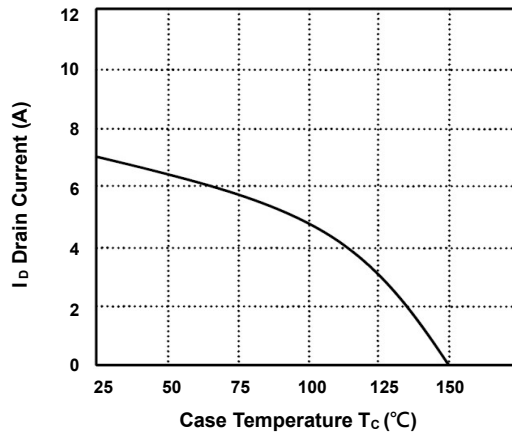

FIG.10-Maximum Drain Current vs Case Temperature

MSP650N700

N-Channel 650-V (D-S) MOSFET

Disclaimer

ALL PRODUCT, PRODUCT SPECIFICATIONS AND DATA ARE SUBJECT TO CHANGE WITHOUT NOTICE TO IMPROVE RELIABILITY, FUNCTION OR DESIGN OR OTHERWISE.

Bruckewell Technology Inc., its affiliates, agents, and employees, and all persons acting on its or their behalf (collectively, "Bruckewell"), disclaim any and all liability for any errors, inaccuracies or incompleteness contained in any datasheet or in any other disclosure relating to any product.

Bruckewell makes no warranty, representation or guarantee regarding the suitability of the products for any particular purpose or the continuing production of any product. To the maximum extent permitted by applicable law, Bruckewell disclaims

- (i) Any and all liability arising out of the application or use of any product.
- (ii) Any and all liability, including without limitation special, consequential or incidental damages.
- (iii) Any and all implied warranties, including warranties of fitness for particular purpose, non-infringement and merchantability.

Statements regarding the suitability of products for certain types of applications are based on Bruckewell's knowledge of typical requirements that are often placed on Bruckewell products in generic applications.

Such statements are not binding statements about the suitability of products for a particular application. It is the customer's responsibility to validate that a particular product with the properties described in the product specification is suitable for use in a particular application. Parameters provided in datasheets and/or specifications may vary in different applications and performance may vary over time.

Product specifications do not expand or otherwise modify Bruckewell's terms and conditions of purchase, including but not limited to the warranty expressed therein.