

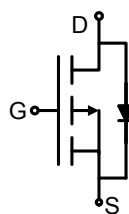
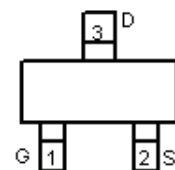

P-Channel Enhancement Mode Power MOSFET

<p>Description</p> <p>The MS23P01S uses advanced trench technology to provide excellent $R_{DS(ON)}$, low gate charge and operation with gate voltages as low as 1.8V. This device is suitable for use as a load switch or in PWM applications.</p> <p>General Features</p> <ul style="list-style-type: none"> ● $V_{DS} = -20V, I_D = -2.6A$ ● $R_{DS(ON)} < 160m\Omega @ V_{GS} = -2.5V$ ● $R_{DS(ON)} < 120m\Omega @ V_{GS} = -4.5V$ ● High power and current handling capability ● Lead free product is acquired ● Surface mount package <p>Application</p> <ul style="list-style-type: none"> ● PWM applications ● Load switch 	<div style="text-align: center;">  <p>Schematic diagram</p>  <p>Marking and pin assignment</p>  <p>SC70-3/ SOT-323 top view</p> </div>
--	---

Package Marking and Ordering Information

Device Marking	Device	Device Package	Reel Size	Tape width	Quantity
A1SHB	MS23P01S	SOT-23	Ø180mm	8 mm	3000 units

Absolute Maximum Ratings ($T_A = 25^\circ C$ unless otherwise noted)

Parameter	Symbol	Limit	Unit
Drain-Source Voltage	V_{DS}	-20	V
Gate-Source Voltage	V_{GS}	± 12	V
Drain Current-Continuous	I_D	-2.6	A
Drain Current -Pulsed ^(Note 1)	I_{DM}	-13	A
Maximum Power Dissipation	P_D	0.9	W
Operating Junction and Storage Temperature Range	T_J, T_{STG}	-55 To 150	$^\circ C$

Thermal Characteristic

Thermal Resistance, Junction-to-Ambient ^(Note 2)	$R_{\theta JA}$	138	$^\circ C/W$
---	-----------------	-----	--------------

Electrical Characteristics ($T_A = 25^\circ C$ unless otherwise noted)

Parameter	Symbol	Condition	Min	Typ	Max	Unit
Off Characteristics						
Drain-Source Breakdown Voltage	BV_{DSS}	$V_{GS} = 0V, I_D = -250\mu A$	-20		-	V
Zero Gate Voltage Drain Current	I_{DSS}	$V_{DS} = -20V, V_{GS} = 0V$	-	-	-1	μA

Parameter	Symbol	Condition	Min	Typ	Max	Unit
Gate-Body Leakage Current	I_{GSS}	$V_{GS}=\pm 12V, V_{DS}=0V$	-	-	± 100	nA
On Characteristics <small>(Note 3)</small>						
Gate Threshold Voltage	$V_{GS(th)}$	$V_{DS}=V_{GS}, I_D=-250\mu A$	-0.4	-0.7	-1	V
Drain-Source On-State Resistance	$R_{DS(ON)}$	$V_{GS}=-4.5V, I_D=-2A$	-	78	120	m Ω
		$V_{GS}=-2.5V, I_D=-1.8A$	-	102	160	m Ω
Forward Transconductance	g_{FS}	$V_{DS}=-5V, I_D=-1A$	6	-	-	S
Dynamic Characteristics <small>(Note4)</small>						
Input Capacitance	C_{iss}	$V_{DS}=-10V, V_{GS}=0V,$ $F=1.0MHz$	-	325	-	PF
Output Capacitance	C_{oss}		-	63	-	PF
Reverse Transfer Capacitance	C_{rss}		-	37	-	PF
Switching Characteristics <small>(Note 4)</small>						
Turn-on Delay Time	$t_{d(on)}$	$V_{DD}=-10V, R_L=5\Omega$ $V_{GS}=-4.5V, R_{GEN}=3\Omega$	-	11	-	nS
Turn-on Rise Time	t_r		-	5.5	-	nS
Turn-Off Delay Time	$t_{d(off)}$		-	22	-	nS
Turn-Off Fall Time	t_f		-	8	-	nS
Total Gate Charge	Q_g	$V_{DS}=-10V, I_D=-2A,$ $V_{GS}=-4.5V$	-	3.2	-	nC
Gate-Source Charge	Q_{gs}		-	0.6	-	nC
Gate-Drain Charge	Q_{gd}		-	0.9	-	nC
Drain-Source Diode Characteristics						
Diode Forward Voltage <small>(Note 3)</small>	V_{SD}	$V_{GS}=0V, I_S=2A$	-	-	-1.2	V
Diode Forward Current <small>(Note 2)</small>	I_S		-	-	-2.6	A

Notes:

1. Repetitive Rating: Pulse width limited by maximum junction temperature.
2. Surface Mounted on FR4 Board, $t \leq 10$ sec.
3. Pulse Test: Pulse Width $\leq 300\mu s$, Duty Cycle $\leq 2\%$.
4. Guaranteed by design, not subject to production

Typical Electrical and Thermal Characteristics

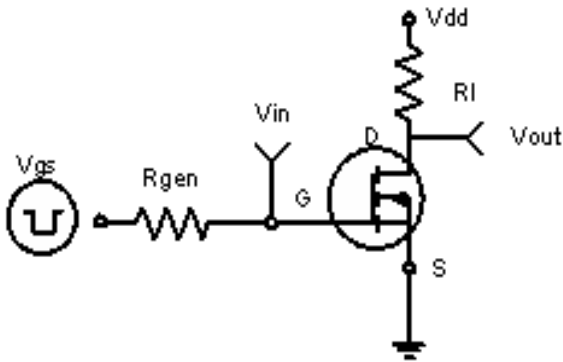

Figure 1: Switching Test Circuit



Figure 2: Switching Waveforms

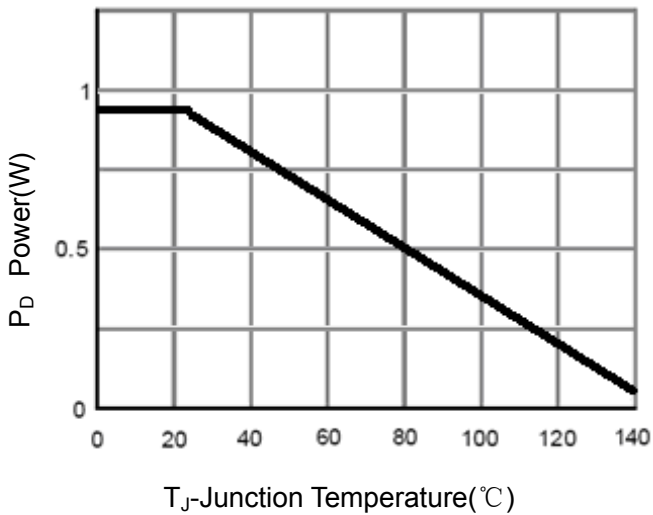

Figure 3 Power Dissipation

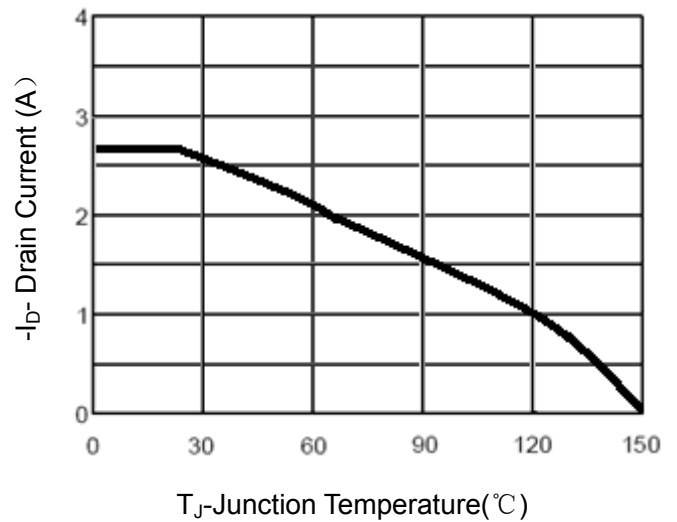

Figure 4 Drain Current

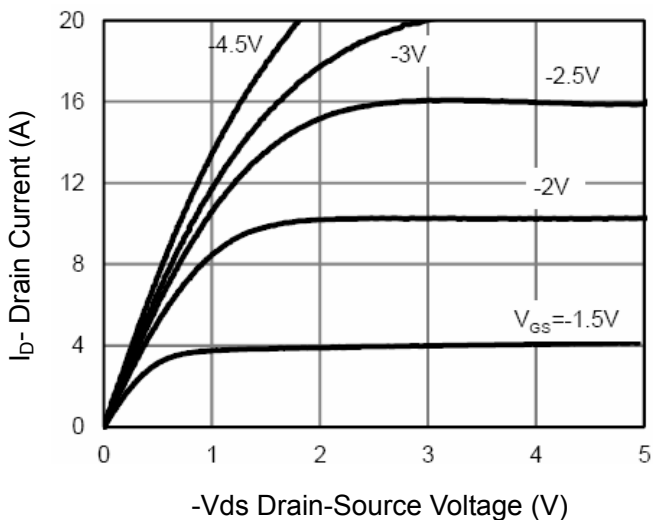

Figure 5 Output Characteristics

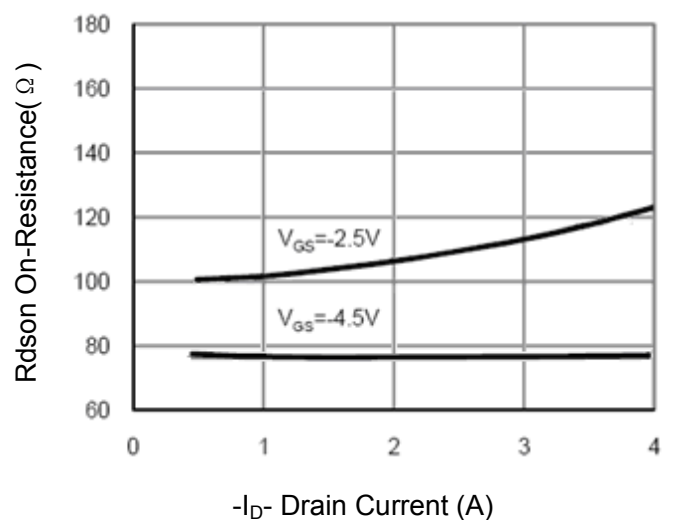

Figure 6 Drain-Source On-Resistance

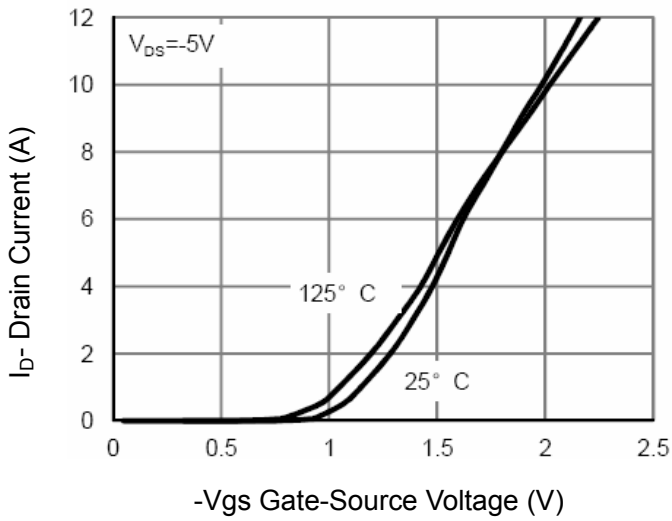

Figure 7 Transfer Characteristics

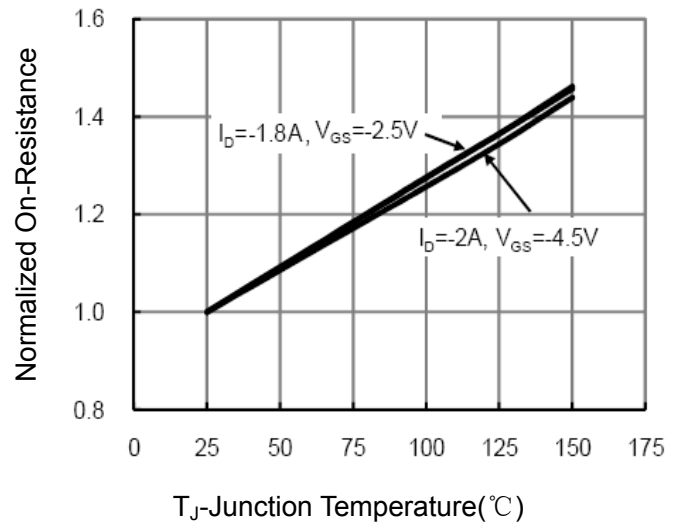

Figure 8 Drain-Source On-Resistance

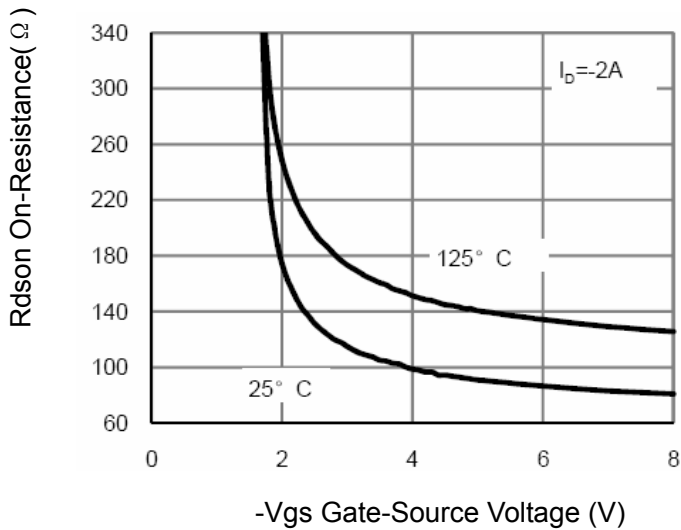

Figure 9 Rdson vs Vgs

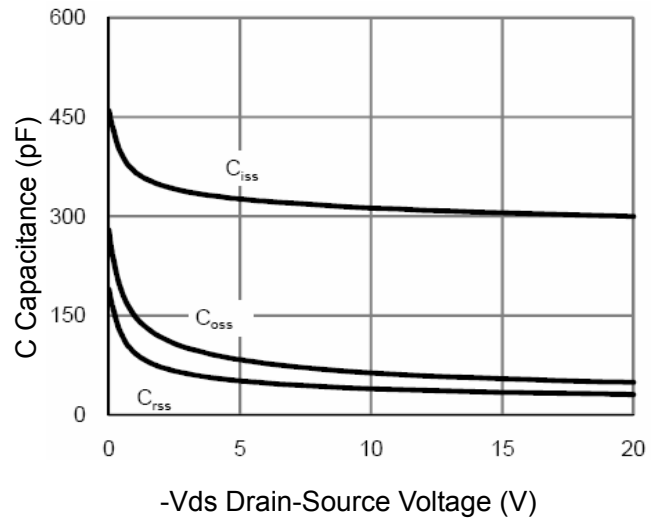

Figure 10 Capacitance vs Vds

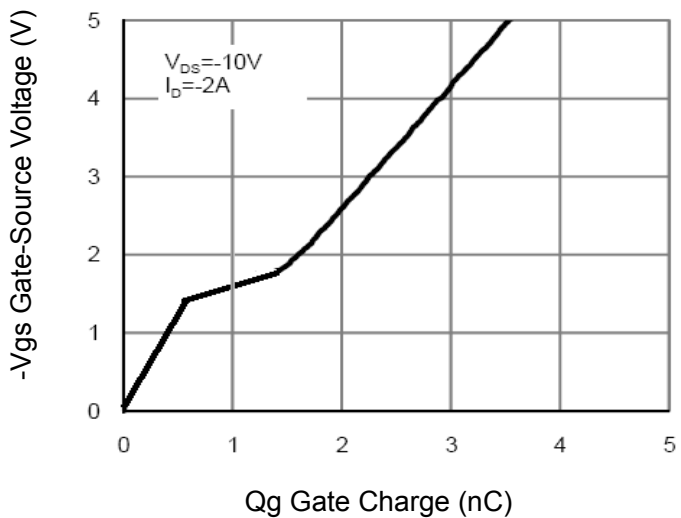

Figure 11 Gate Charge

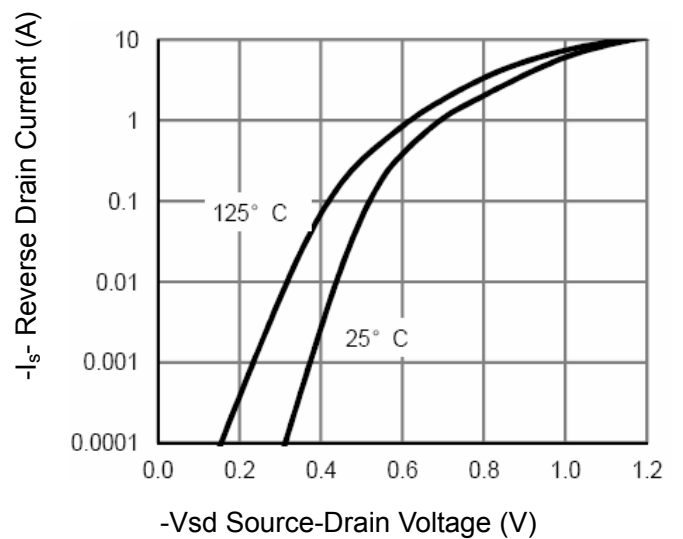

Figure 12 Source- Drain Diode Forward

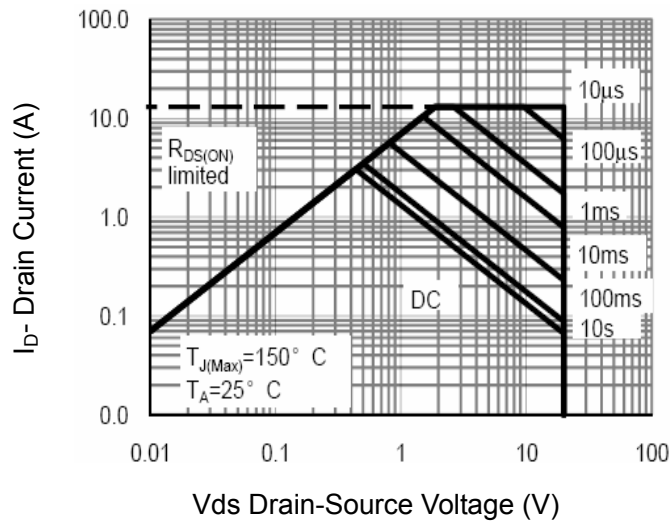

Figure 13 Safe Operation Area

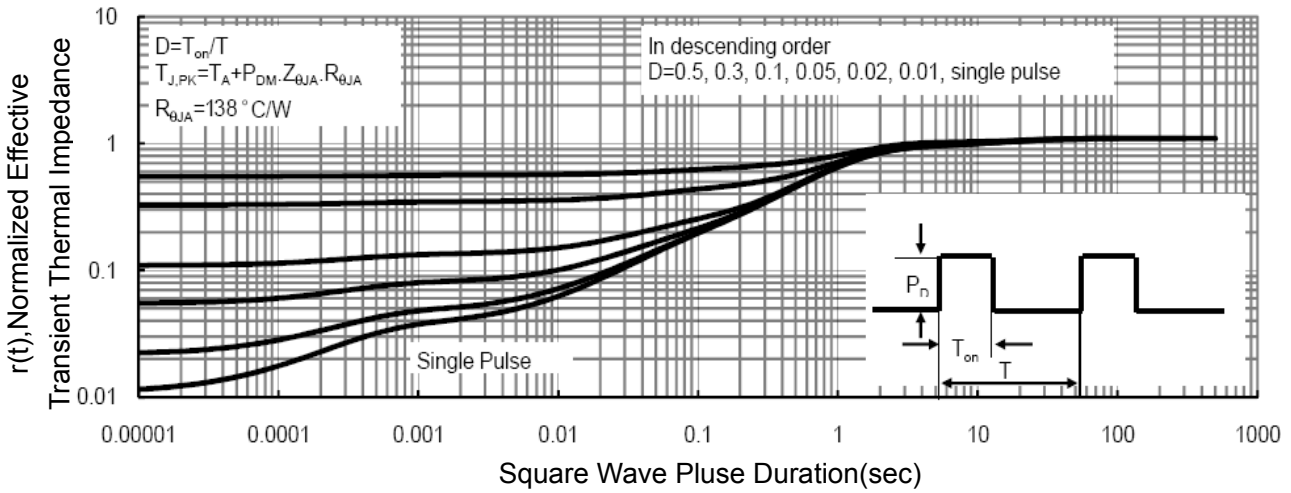
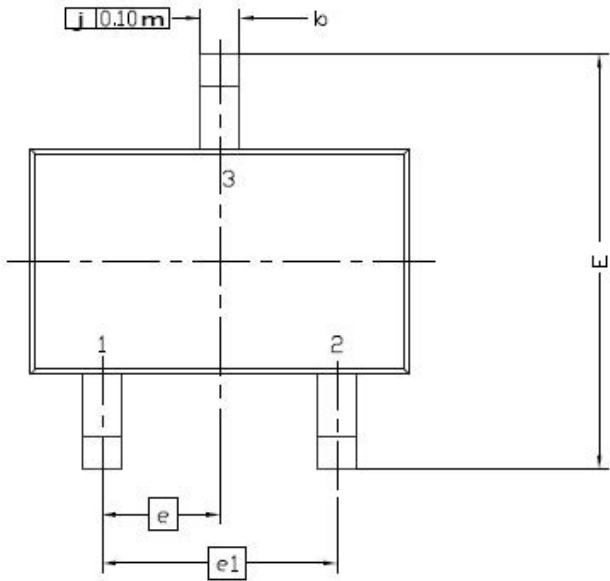

Figure 14 Normalized Maximum Transient Thermal Impedance

SC70-3 Package Information



DIM.	MILLIMETERS			INCHES		
	MIN	NOM	MAX	MIN	NOM	MAX
A	0,900	0,95	1,10	0,035	0,037	0,043
A1	0,00	---	0,10	0,000	---	0,004
A2	0,70	0,90	1,00	0,028	0,035	0,039
k	0,15	0,22	0,30	0,006	0,016	0,012
c	0,08	0,127	0,20	0,003	0,005	0,008
D	2,10 BSC			0,083 BSC		
E	2,30 BSC			0,091 BSC		
E1	1,30 BSC			0,051 BSC		
e	0,65 BSC			0,026 BSC		
e1	1,30 BSC			0,051 BSC		
L	0,26	0,40	0,46	0,010	0,015	0,018
L2	0,254BSC			0,010BSC		
R	0,10	---	---	0,004	---	---
θ	0°	4°	8°	0°	4°	8°
$\theta1$	7°NOM			7°NOM		

