

## Digital Transistor

## DTA(R<sub>1</sub>=R<sub>2</sub> SERIES)E

### FEATURES

- Epitaxial planar die construction.
- Complementary NPN types available(DTC).
- Built-in biasing resistors,R<sub>1</sub>=R<sub>2</sub>.
- Also available in lead free version.

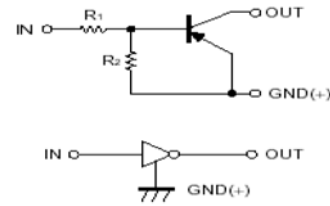

### APPLICATIONS

- The PNP style digital transistor.

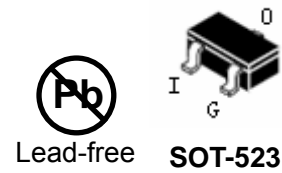

### ORDERING INFORMATION

Type No.	Marking	Package Code
DTA114EE	14	SOT-523
DTA124EE	15	SOT-523
DTA143EE	13	SOT-523
DTA144EE	16	SOT-523

### MAXIMUM RATING @ Ta=25°C unless otherwise specified

Symbol	Parameter	Value	Units	
V <sub>CC</sub>	Supply Voltage	-50	V	
V <sub>IN</sub>	Input Voltage	DTA114EE DTA124EE DTA143EE DTA144EE	+10 to -40 +10 to -40 +10 to -30 +10 to -40	V
I <sub>o</sub>	Output Current	DTA114EE DTA124EE DTA143EE DTA144EE	-50 -30 -100 -30	mA
I <sub>C</sub> (Max.)	Output current	ALL	-100	mA
P <sub>D</sub>	Power Dissipation		150	mW
R <sub>θJA</sub>	Thermal Resistance, Junction to Ambient Air		833	°C/W
T <sub>j</sub> , T <sub>stg</sub>	Operating and Storage and Temperature Range		-55 to +150	°C

## ELECTRICAL CHARACTERISTICS @ Ta=25°C unless otherwise specified

Parameter	Symbol	Test conditions	MIN	TYP	MAX	UNIT	
Input Voltage	$V_{I(off)}$	$V_{CC}=-5V, I_O=-100\mu A$	-0.5	-1.1	-	V	
Input Voltage	DTA114EE DTA124EE DTA143EE DTA144EE	$V_O=-0.3V, I_O=-10mA$ $V_O=-0.2V, I_O=-5mA$ $V_O=-0.3V, I_O=-20mA$ $V_O=-0.3V, I_O=-2mA$	-	-1.9	-3		
Output Voltage	DTA114EE DTA124EE DTA143EE DTA144EE	$I_O/I_I=-10mA/-0.5mA,$	-	-0.1	-0.3		V
Output Voltage	$V_{O(on)}$						
Input Current	DTA114EE DTA124EE DTA143EE DTA144EE	$V_I=-5V$	-	-	-0.88 -0.36 -1.8 -0.18	mA	
Output Current	$I_{O(off)}$	$V_{CC}=-50V, V_I=0V$	-	-	-0.5	$\mu A$	
DC Current Gain	DTA114ECA DTA124ECA DTA143ECA DTA144ECA	$V_O=-5V, I_O=-5mA$ $V_O=-5V, I_O=-5mA$ $V_O=-5V, I_O=-10mA$ $V_O=-5V, I_O=-5mA$	30 56 20 68	-	-	k $\Omega$	
Input Resistor	DTA114ECA DTA124ECA DTA143ECA DTA144ECA	$R_1(R_2)$	7 15.4 3.29 32.9	10 22 4.7 47	13 28.6 6.11 61.1		
Resistance Ratio	$R_2/R_1$	-	0.8	1	1.2		
Gain-Bandwidth Product	$f_T$	$V_{CE}=-10V, I_E=5mA,$ $f=100MHz$	-	250	-		MHz

## TYPICAL CHARACTERISTICS @ Ta=25°C unless otherwise specified

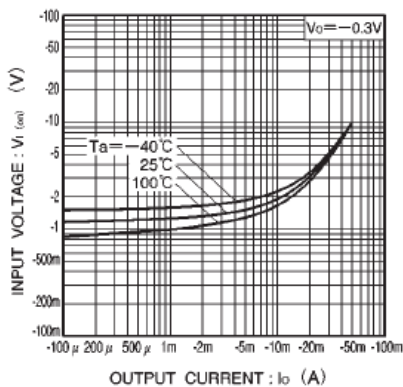

Fig.1 Input voltage vs. output current (ON characteristics)

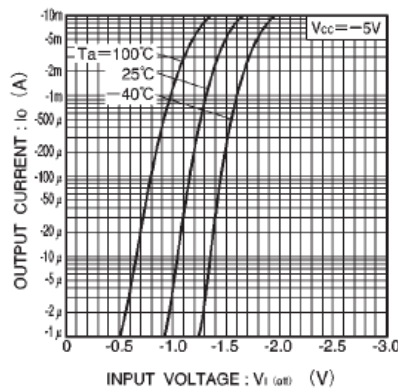

Fig.2 Output current vs. input voltage (OFF characteristics)

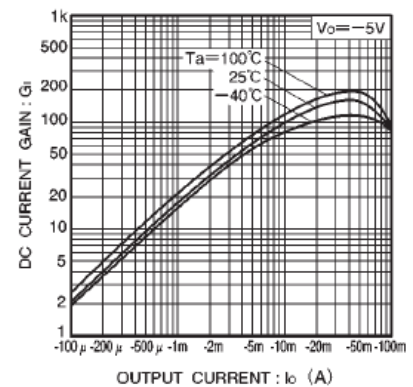

Fig.3 DC current gain vs. output current

# Digital Transistor

# DTA(R<sub>1</sub>=R<sub>2</sub> SERIES)E

## PACKAGE OUTLINE

Plastic surface mounted package

SOT-523

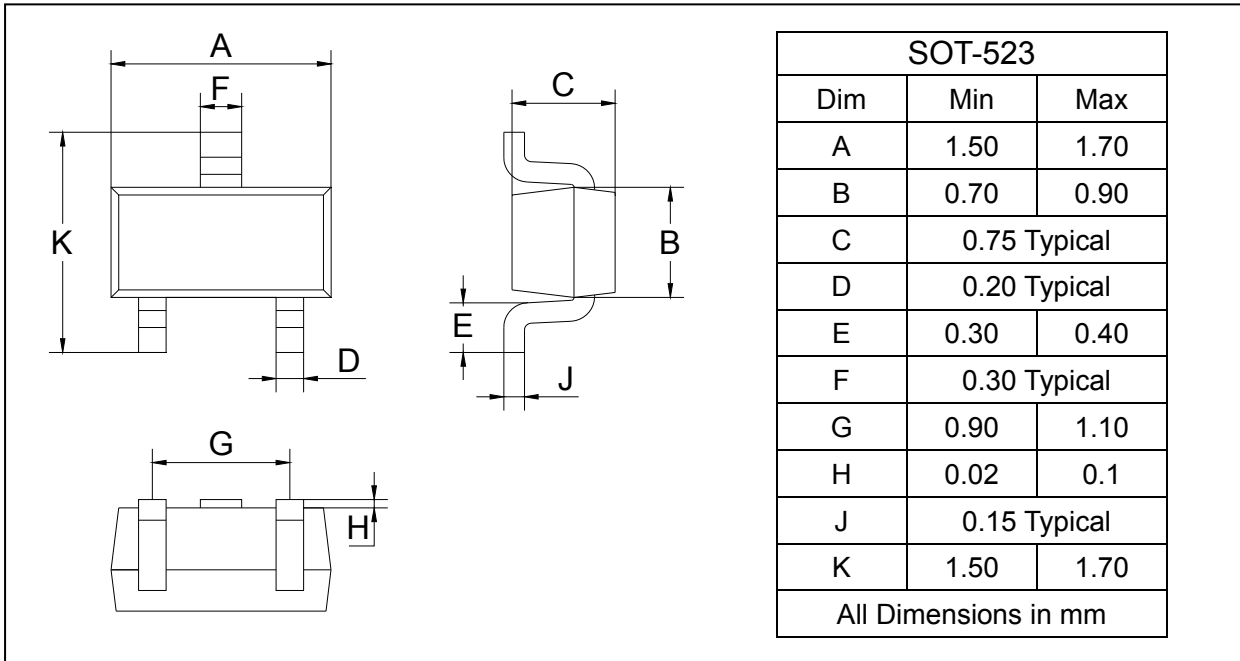

## SOLDERING FOOTPRINT

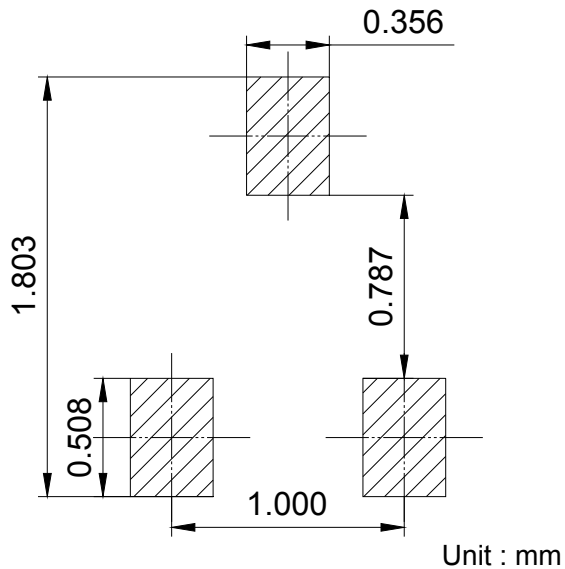

## PACKAGE INFORMATION

Device	Package	Shipping
DTA114EE/124EE/143EE/144EE	SOT-523	3000/Tape&Reel